

SL FAST FLAT

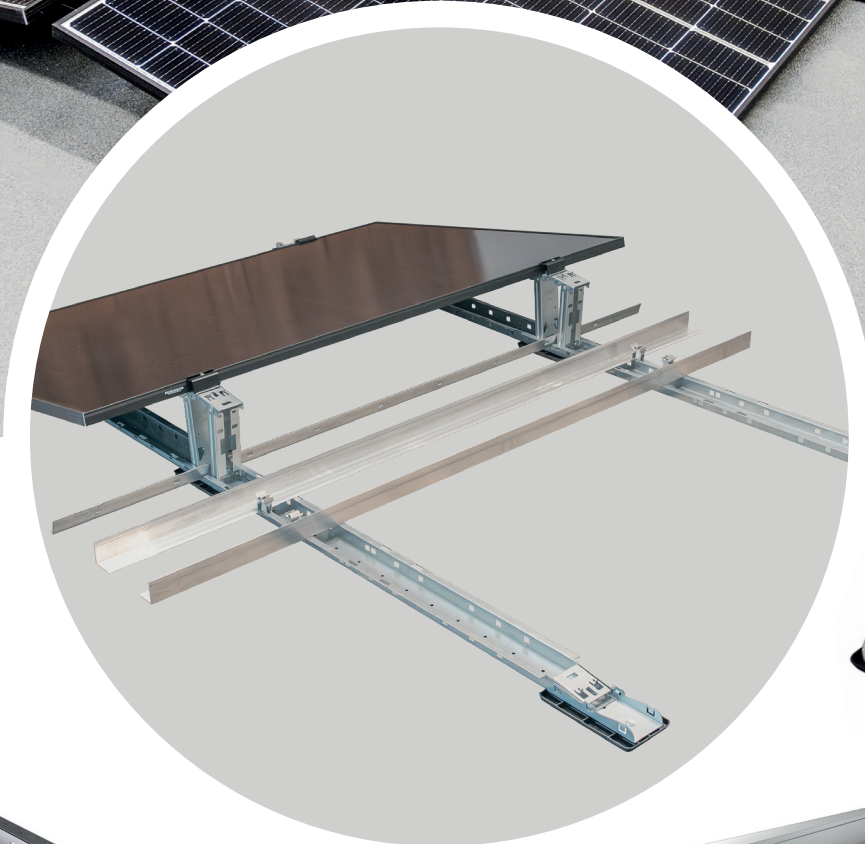

SLRack

Schletter Ludwig



Visit our
website:
www.sl-rack.com



GERMAN INNOVATION

Innovative Product Development



„Our racking systems have been developed since 1996 and are continuously optimized. Pre-assembled components that are quick and easy to install, prompt order processing, a reliable product supply and cost-effectiveness are our focus.

All our components follow a convenient top-down installation approach, ensuring a smooth and time-saving workflow. SL Rack systems are installer-friendly, intuitive and standardized, while still providing the flexibility to adapt to each respective project site.“

Sincerely,

Ludwig Schletter

SL Rack in numbers:



26..... Years of experience

30..... GW installed worldwide

200..... Employees are happy to help!

EU..... Almost exclusively manufactured in Germany and Europe



Visit our
website:
www.sl-rack.com



Check out our
YouTube-channel:
[Installation videos »](#)

*Our warranty conditions apply. They are available at www.sl-rack.com

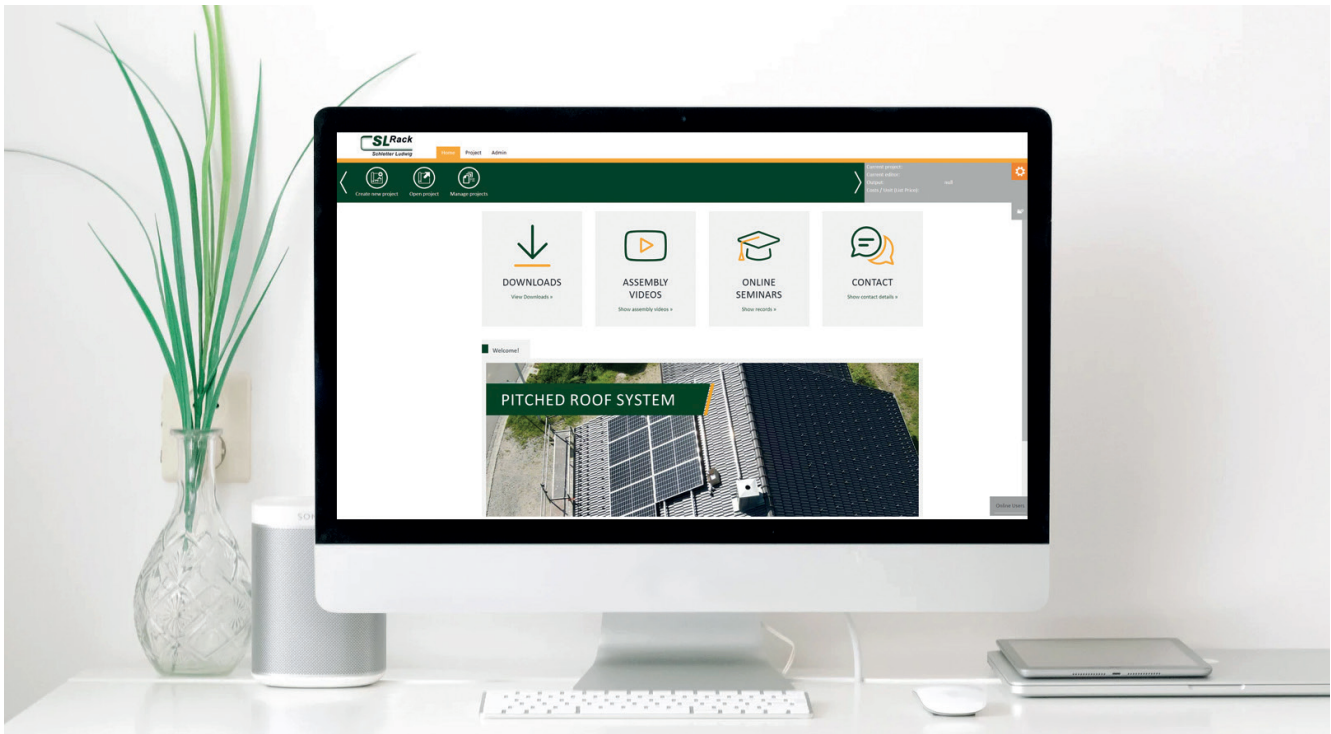

Welcome to our **Solar.Pro.Tool**

Solar.Pro.Tool



Design your rooftop projects quickly and with ease using our **Solar.Pro.Tool**, available on our website.

- » For all pitched and flat roofs
- » Finish your design in 10 simple steps
- » In 2D or 3D (PDF, DXF, DWG)
- » Building authority certified
- » Precise ballast calculations for any type of flat roof
- » Drawings and bill of material

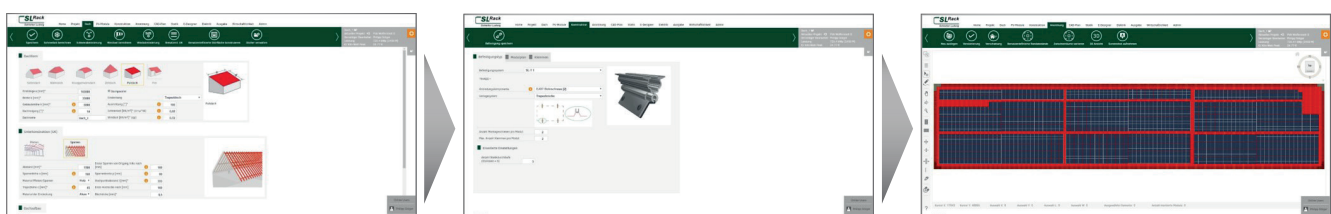

The many advantages of **SL Fast Flat**

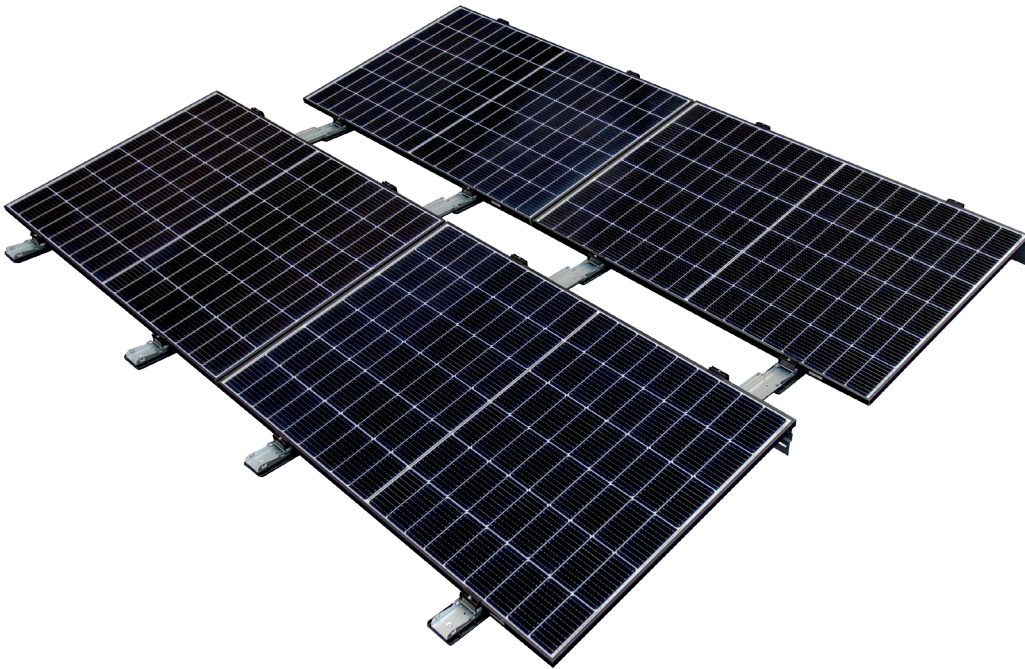

- » Quick and mistake-proof installation due to pre-assembled components and tool-free click system.
- » Flexible use for south and east-west orientation on any flat roof.
- » Smooth roof loading due to optimum load distribution, protecting roof membrane and insulation.
- » Space-savings in warehousing and logistics with standardized and compact components.
- » Durability and sustainability due to high-quality materials and 100% production in Germany.

SL Fast Flat south and east/west is available in both, corner clamping and quarter-point/green-zone clamping. The respective rows can be assembled in just a few simple steps.

Assembly

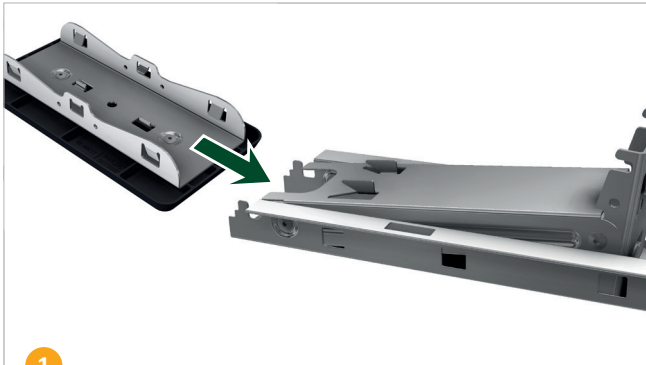

1
Connect the Base Plate with the Basic Frame.

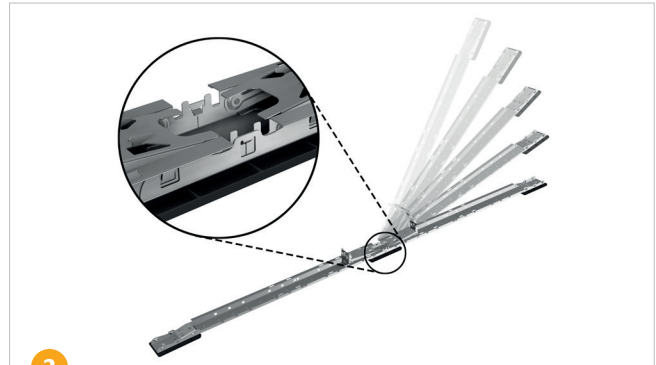

2
Connect the Basic Frames to form a continuous rail.

OPTIONAL:

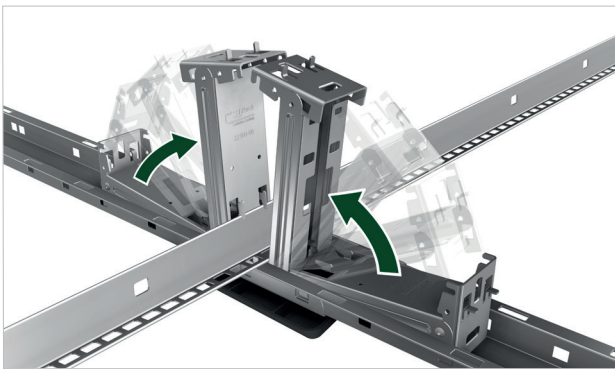

Install the Quarter-Point Strut for long-side/green zone clamping.



Place the ballast blocks into the Basic Frame.



Larger stones may be placed on top of the Basic Frame.

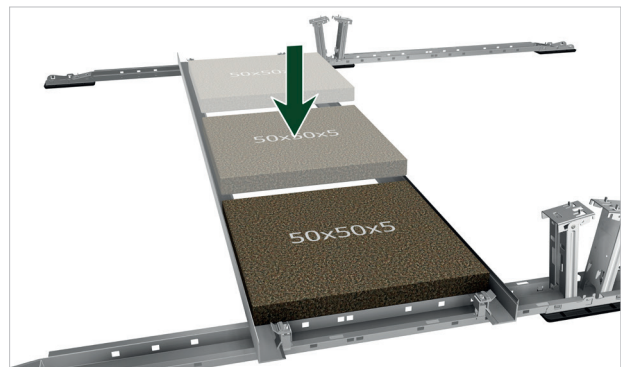

Install the Ballast Brackets and position the ballast blocks in between.

Accessories

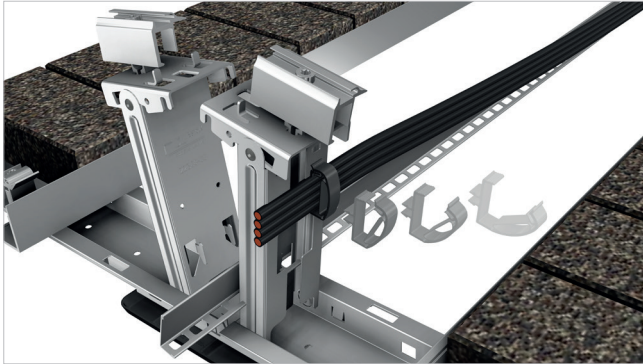

Press the Cable Clip into the Basic Frame or the Quarter-Point Strut.



Fixate the Wind Deflector using the Universal Clamp.

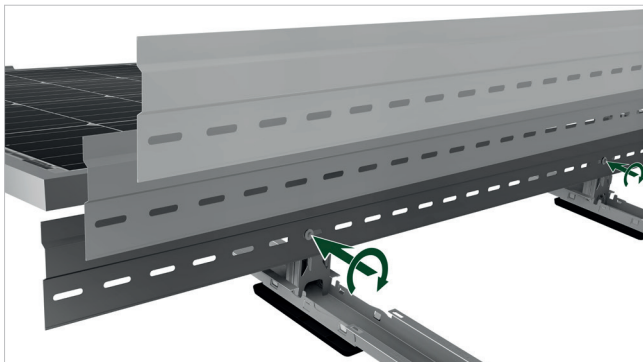

Fasten the Wind Deflector light.

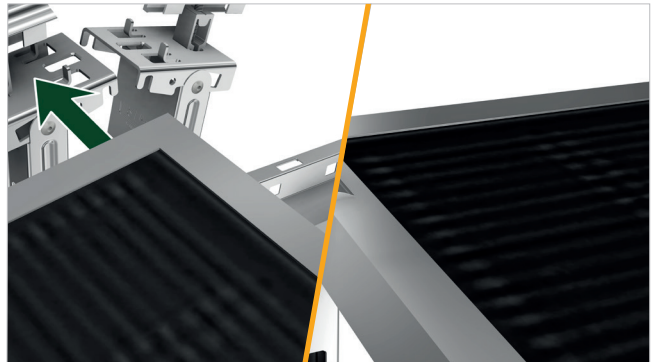

Attach the modules with our SL module clamp Vario.

Lightning protection

Please refer to the Lightning Protection data sheet for information on the connection to a lightning protection system.

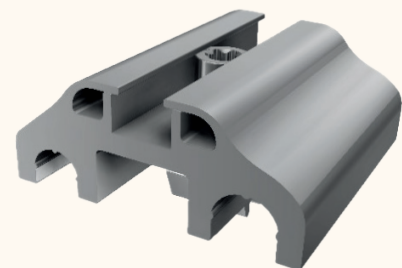

Figure 13. Lightning protection clamp, certified to DIN EN 62561

Galvanised steel on flat roofs

Steel, especially hot-dip galvanised steel, plays a significant role in many industries, including renewable energies. We have been building ground mount PV systems made of hot-dip galvanised steel for more than 25 years. We therefore want to use our experience in another field as well: Flat roofs. On flat roofs, the steel is exposed to similar, sometimes less corrosive conditions than with ground mount applications. To ensure that installers can use the product in any area with confidence, we have set the Corrosivity Level at C4 (see table on corrosivity on page 8). All our components are coated with ZM430.

Contact Corrosion

With SL Fast Flat the risk of contact corrosion between two metals is low and considered unproblematic. Should a system be installed near the coast or salt water, protective measures can be checked and initiated. To illustrate: Depending on the metal pairing (aluminium - zinc - hot-dip galvanized steel, for example Basic Frame – Mid Clamp), there is a difference in electrical potential of varying degrees. The greater the difference in this potential, the higher the corrosivity.

Metal Pairing	Atmosphere			Water	
	City	Industry	Ocean	Fresh Water	Salt Water
Aluminum – Hot-Dip Galvanized Steel	0	0 - 1	0 - 1	1	1 - 2

Legend:

0 = no significant corrosion of the metal pairing

1 = slightly increased corrosion, but no protective measures recommended

2 = increased corrosion, insulating protective measures recommended

3 = severe contact corrosion, avoid metal pairing

This information is subject to case-by-case verification during project planning and is provided by SL Rack GmbH as a non-binding recommendation.

Corrosiveness categories Corrosion stresses	Corrosivity	Examples of typical surroundings	Thickness reduction after 1st year of installation		Recommended zinc coating
			Carbon steel	Zinc	
C1 Insignificant	Very low Slightly aggressive Interior	Only heated indoor spaces, insulated buildings ($\leq 60\%$ r. h.)	$\leq 1,3 \mu\text{m}$	$\leq 0,1 \mu\text{m}$	No zinc coating
C2 Low	Low Moderately aggressive Exterior/interior	Unheated buildings, low-polluted atmosphere, dry climate. Mainly rural areas.	$>1,3 - 25 \mu\text{m}$	$>0,1 - 0,7 \mu\text{m}$	Z600
C3 Moderate	Moderate Slightly aggressive Exterior/interior	Rooms with high humidity and low air pollution. Urban and industrial atmo- sphere with moderate SO_2 pollution or temperate climate.	$>25 - 50 \mu\text{m}$	$>0,7 - 2,1 \mu\text{m}$	ZM310
C4 Strong	High Moderately aggressive Exterior/interior	Swimming pools. Industrial atmosphere and coastal atmosphere with moderate salt load.	$>50 - 80 \mu\text{m}$	$>2,1 - 4,2 \mu\text{m}$	ZM430
C5 Very strong	Very high Aggressive Exterior/interior	Environments with almost constant con- densation and heavy air contamination. Industrial atmosphere with high relative humidity and aggressive atmosphere.	$>80 - 200 \mu\text{m}$	$>4,2 - 8,4 \mu\text{m}$	ZM600

The values in the table above for the galvanizing thicknesses/methods, depending on the corrosivity category, are based on DIN 55928-8 („Corrosion protection of steel structures by coatings and overlays; Part 8: Corrosion protection of load-bearing thin-walled components“) and are at least at the level of the standard.

This information is subject to case-by-case verification during project planning and is provided by SL Rack GmbH as a non-binding recommendation.

All roof insulation has a certain compressive strength, and many roofs have or have had compressive soft insulation installed. On these roofs, the resistance value is very low; if a PV system is installed on the roof with too small a contact area, damage and loss of insulation can occur.

Choice of Base Plate

The contact surface area must be increased to protect the insulation. The optimum number and size of base plates can be determined in our design software on the basis of insulation resistance values.

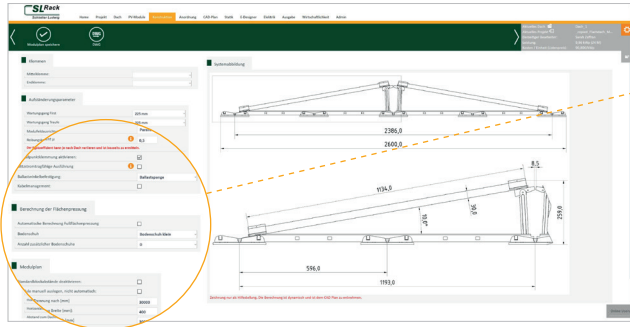

Calculation of the surface pressure

Automatic calculation of the foot surface pressure

Maximum compressive strength of the insulation [kn/m2].

Base Plate

Number of additional Base Plates

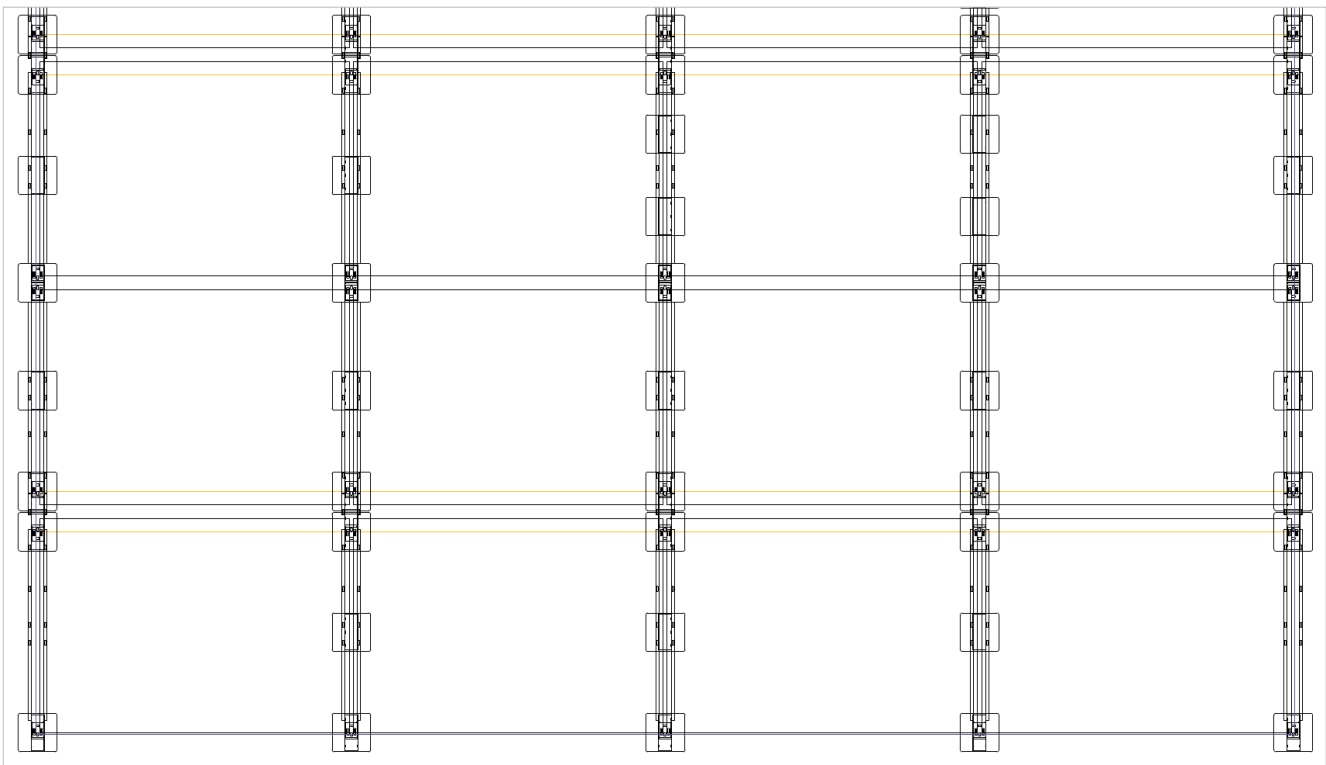

Image: Solar.Pro.Tool Design with the required amount of Base Plates

Basic Frame

- » Works for south and east-west orientation, corner and long-side/green zone clamping as well as fixation to trapezoidal roofs
- » Cost-effective warehousing and logistics
=> 200 rails per Euro pallet
- » 100 % pre-assembled for a tool-free installation



Item no. 22300-00	Dimensions	Weight	Material	PU
Basic Frame	L 1190 mm, W 105 mm, H 84 mm	1.62 kg	Galvanized steel ZM430	200

Base Plate PVC 100x200

- » UV-resistant and free from plasticizers
- » Up to 3 additional Base Plates per rail



Item no. 22300-20	Dimensions	Weight	Material	PU
Base Plate PVC 100x200	L 200 mm, W 100 mm, H 30 mm	0.34 kg	Galvanized steel ZM430	35

Base Plate PVC 200x200

- » UV-resistant and free from plasticizers
- » Up to 3 additional Base Plates per rail
- » Increased contact area reduces bearing pressure



Item no. 22300-30	Dimensions	Weight	Material	PU
Base Plate PVC 200x200	L 200 mm, W 200 mm, H 30 mm	0.42 kg	Galvanized steel ZM430/HDPE	20

Base Plate EPDM

- » EPDM-pad for increased coefficient of friction
- » Up to 3 additional Base Plates per rail
- » Increased contact area reduces bearing pressure



Item no. 22300-10	Dimensions	Weight	Material	PU
Base Plate EPDM 200x200	L 200 mm, W 200 mm, H 30 mm	0.42 kg	Galvanized steel ZM430/EPDM	20

Base Plate PVC light

- » UV-resistant and free from plasticizers
- » Increased contact area reduces bearing pressure



Item no. 22300-15	Dimensions	Weight	Material	PU
Base Plate PVC light	L 200 mm, W 200 mm, H 30 mm	0.125 kg	HDPE	35

Spacer

- » Minimal shading for south system
- » Maintenance aisle for east-west system



VARIANTS

	Dimensions	Weight	Material	PU
Item no. 22300-220	L 220 mm, W 105 mm, H 30 mm	0.33 kg	Galvanized steel ZM430	50
Item no. 22300-390	L 390 mm, W 105 mm, H 30 mm	0.42 kg	Galvanized steel ZM430	50
Item no. 22300-700	L 700 mm, W 105 mm, H 30 mm	0.75 kg	Galvanized steel ZM430	150

Ballast Bracket

- » Holds ballast blocks in various sizes
- » Fixation of the ballast blocks
- » For module length up to 2200 mm



Item no. 21116-2300	Dimensions	Weight	Material	PU
Ballast Bracket	L 2300 mm, W 50 mm, H 50 mm	0.8 Kg	Aluminium	150

FLA Universal Clamp

- » Universally applicable clamp for SL rack systems
- » For attachment of Ballast Brackets, Wind Deflectors as well as micro inverters
- » Installation from the top with Torx 40



Item no. 21114-00	Dimensions	Weight	Material	PU
FLA Universal Clamp	L 35 mm, W 25 mm, H 60/45 mm	0.035 Kg	Aluminium/Stainless steel	200

Quarter-Point Strut

- » Connects and stabilizes up to three Basic Frame rows
- » Integrated cable routing for efficient cable management
- » Can aid assembly by serving as a jig between Basic Frame rows. Works for corner and green-zone clamping alike.



Item no. 22303-2585	Dimensions	Weight	Material	PU
Quarter-Point Strut	L 2585 mm, W 16 mm, H 40 mm	1.07 Kg	Galvanized steel ZM430	20

Wind Deflector

- » Specially developed for the south system
- » Optimized aerodynamics for ballast reduction
- » Fixation by clamping onto the Spacers



Item no. 22301-2595	Dimensions	Weight	Material	PU
Wind Deflector	L 2595 mm, W 220 mm, H 15 mm	4.1 Kg	Galvanized steel ZM430	100

Wind Deflector light

- » Works for south and east-west systems
- » Optimized aerodynamic for ballast reduction
- » Attaches to the ridge adaptor

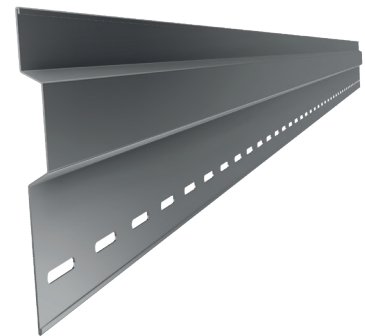

Item no. 22302-2595	Dimensions	Weight	Material	PU
Wind Deflector light	L 2595 mm, W 145 mm, H 15 mm	2.29 Kg	Galvanized steel ZM430	10

Cable Clip

- » Elevated cable routing prevents water accumulation
- » UV-resistant
- » Can be attached to the Basic Frame and Quarter-Point Strut



Item no. 22300-41	Dimensions	Weight	Material	PU
Cable Clip	L 50 mm, W 10 mm, H 20 mm	0.004 Kg	PA66	100

Lightning Protection Clamp Top

- » Easy connection to external lightning protection and equipotential bonding systems
- » Suitable for grounding wire with a diameter of 8 and 10 mm
- » Certified to DIN EN 62561

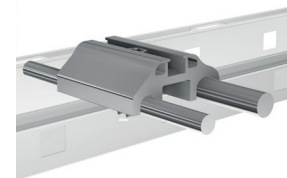

Item no. 91518-00	Dimensions	Weight	Material	PU
Lightning Protection Clamp Top	L 52 mm, W 52 mm, H 38/23 mm	0.074 Kg	Aluminium/Stainless steel	100

Base Plate Anchor

- » Anchor for ballast-free roof attachment
- » Attaches to hanger bolts and anchors
- » Mounting of cable trays



Item no. 22300-50	Dimensions	Weight	Material	PU
Base Plate Anchor	L 200 mm, W 200 mm, H 30 mm	0.700 Kg	Galvanized steel ZM430	20

Self-tapping screw 6,3x16 TX40



- » Screw connection with Torx 40
- » For attachment of Wind Deflector light and connection to lightning protection systems

Item no. 73163-16	Dimensions	Weight	Material	PU
Self-tapping screw 6,3x16 TX40	L 14 mm, W 6 mm, H 6 mm	0.01 Kg	Stainless steel	100

Development

- » More products under development
- » Learn more about future developments at sales@sl-rack.de



FLA Coefficient of Friction Measuring Kit

Item no. 09500-50

Complete tool set for determination of the coefficient of friction and ballast calculation. Content:

- » Precision spring scale for tensile force measurement up to 1000 g.
- » Made from sturdy, anodized aluminum with tara function.
- » Square aluminum block „Königsberger friction block“, weight 1 kg.
- » Various test pads for realistic surface conditions.
- » Works for all flat roof systems.



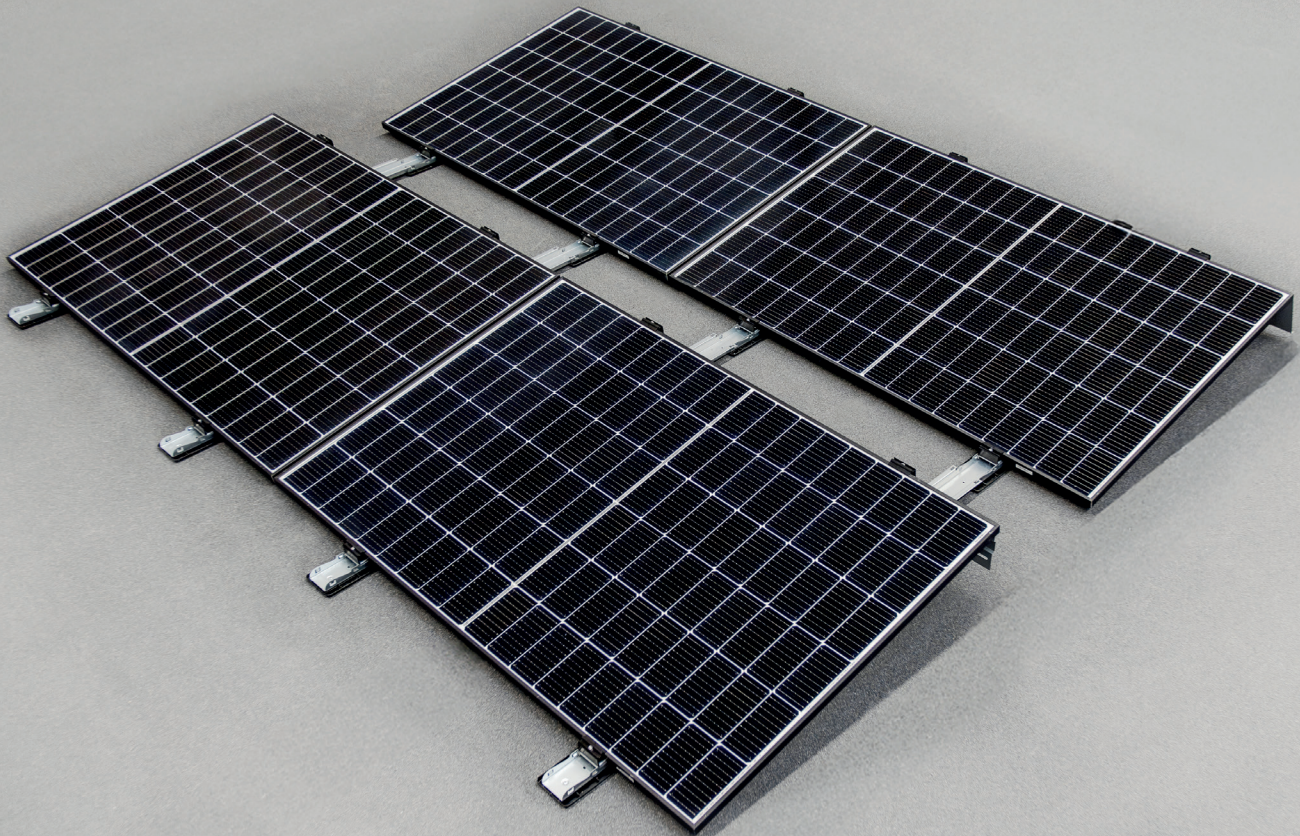

SL Rack
[Website](#)



SL Rack
[YouTube](#)



SL Rack
[Online ordering system](#)



Contact us
for an offer:

SL Rack GmbH
Münchener Straße 1
83527 Haag i. OB
Email: sales@sl-rack.com
Phone: +49 8072 3767-0
www.sl-rack.com